

Point-of-Use System (POU)

Crystal Mountain recommends the following procedures for Receiving, Cleaning, Installing and Using its Point of Use coolers:

Receiving

Inspect the carton for evidence of shipping or handling damage. If order is not inspected immediately upon delivery, the individual signing for the cooler(s) should sign for the shipment with the following: “**Goods received un-inspected**” or “**Goods received unopened**”.

**** In case of shipping damage, claims should be filed promptly with the carrier.**

Cleaning

Although care has been taken to provide you with clean parts, it is recommended that the POU Kit assembly be rinsed well with clean drinking water prior to use.

If desired, a mild dishwashing liquid soap can be used. Rinse well.

**** DO NOT use bleach or abrasive cleaners.**

To clean the cooler itself, please see After Installation section following and the pages on Cleaning & Sanitisation elsewhere in the Service Manual.

Before Installation

1) Installer

Correct installation of POU equipment is vital in order to ensure safe and efficient operation. In Europe, we recommend that installers hold at least the qualifications of the European Point of Use Drinking Water Association (EPDWA) Installation & Hygiene modules. Some contracts will insist on other national trainings/certifications for anyone installing a water system that touches the mains water system.

 Crystal Mountain does not **GUARANTEE** and is not **RESPONSIBLE** for any work/installation carried out by Distributors or Installers.

2) Cooler, Fittings & Materials

Begin with a standard Crystal Mountain water cooler and Point of Use lid & cover or a Crystal Mountain cooler built especially for use as a POU unit.

All fittings must be of appropriate quality and suitable for the purpose, specified for use with potable water and pressure rated for use with mains water.

In the UK, fittings should meet WRAS/WRC standards.

-  Crystal Mountain does not **GUARANTEE** and is not **RESPONSIBLE** for quality or operation of any fittings or service appliance such as Saddle Valves/Stop Taps, Pressure Reducing/Limiting Valves or Leak Detection Devices installed by any installer.

Necessary Fittings include:

i) ¼" OD Plastic Tubing

You will need sufficient tubing to connect the cooler to a filter (if using a filter), and sufficient tubing to reach easily from the cooler to the mains water supply connection (saddle valve), and for properly installing any additional units such as Pressure Reducing Valve or Leak Detection devices. Further tubing considerations for installation are listed under INSTALLATION below.

ii) Saddle Valve

A connection device to the mains water system. Must have built-in back flow protection for attachment to mains water supply pipe. If a self-cutting saddle valve is used it must be the type that “punches” a hole into the copper pipe. The saddle valve that cuts a disc into the pipe must not be used. General installation instructions for this device are under the INSTALLATION heading below.

OR

iii) Stop Tap or Isolating Valve

This is an alternative to a Saddle Valve connection. A stop tap is a means of shutting off the water supply to the POU cooler, usually found fitted after a hard TEE connection (compression type) or a Sweated TEE (soldered type). There are variations in types of stop tap/isolating valves available – Whatever you choose, in the United Kingdom, it should be WRAS/WRC approved. Please check local water supply regulations.

iv) Filters (Optional but conventionally used)

- Filters should be located within or immediately adjacent to the POU Cooler.
- They should not be fitted at the connection point to the water supply unless the length of tubing run makes this necessary.
- Filters must be fitted in accordance with manufacturer guidelines and secured to prevent movement.
- Filters must be flushed prior to connection to the POU Cooler.

General installation considerations and instructions for filters can be found under the INSTALLATION heading below.

-  **Note:** Crystal Mountain recommends the use of the following devices with all our POU coolers.

We do not guarantee the devices or installation thereof.

v) Pressure Reducing or Pressure Limiting Valve

It is recommended that a pressure limiting valve (PLV/PRV) is installed at the point of connection especially when the water supply pressure may exceed specifications of fittings. This could help prevent leaks in many locations where high mains pressure is a problem, but should be used on any installation to prevent

any irregular pressure overload of the system which may lead to leaks. The average pressure in the mains at a commercial site in the UK is between 4 and 6 bars. A limiter (Pressure Reducing Valve) brings it down to about 2 bar. At 1 bar, the filters cannot work properly, leaving carbon in the water, and no pressure through the faucets.

General installation instructions and safety guidelines for this device are under the INSTALLATION heading below.

vi) Leak Detection and Prevention Device

It is strongly recommended that a leak detection and prevention device is fitted between the water supply and the POU Cooler ie a WaterBlock. These devices measure the gallons flowing through it and shut off water flow after a certain level is reached. This protects if there is a problem with unchecked water flow – a leak. These devices, though somewhat expensive, are essential insurance for anyone using POU systems.

They require careful setting on site and should be well understood by any installer. General installation instructions for this device are under the INSTALLATION heading below.

3) Location

Site Survey

A detailed site survey must be made in advance of each installation to provide information for the installer as to fittings that may be required, tube length required etc. Common sense and professional knowledge should be engaged when selecting a site.

Factors to Consider

- Health & Safety, electrical or other regulations
- Regulations concerning operation of and interference with water supplies within the building
Location of the POU unit
- Suitable electric and water supply. Ideally, all water and electrical service points will be sited within 1 (one) meter of cooler location.
- Suggested route for water supply to the POU cooler
- Any hazards that may affect installation. Care should be taken that the cooler avoids blocking throughways, fire exits and heat sources.
- Coolers should not be placed in direct sunlight or sensitive areas that could result in major damage from leaks i.e. in or above computer room.
- Is Water Pressure sufficient to operate a POU cooler (see Pressure Reducing Valve, above) – must be over 1 bar for proper flow through filters and tap.
- The flow direction of water. Ensure you are downstream of the nearest stop tap.

Potable Water Supply

The Water supply must be a designated source of potable water – this must be checked and confirmed during the site survey.

The following types of water supply are suitable for supplying POU coolers.

- Water from a direct mains water supply
- Water from a storage cistern designated as potable water, which should be under local approvals.
- Water supplied from a well or borehole or other local water supply that is designated as a source of potable water.
- Water held in tanks is not suitable.

Although it may seem obvious, the following are examples of water sources not suitable for supplying POU coolers. There have been documented examples of connections being made to such supplies.

- Fire Hydrants
- Fire Sprinklers
- Central Heating Systems
- Processed Water Supplies
- Tanks, as mentioned above

Pipework

Flush all pipe work before connecting to the POU unit to remove debris.

Dead-ends should be avoided or removed. A dead end is a section of pipe work that is not regularly refreshed with water. As the water within it is not replaced it can become TAINTED over a period of time. It is preferable to connect to, or as close as possible to, a RUNNING water supply.

Electrical Supply

Ensure electrical supply is 240v, 13 amp either 3 pin or fused spur.

Connections other than the fitting of the mains lead, with fitted plug, between the POU Cooler and the mains power supply should be made by a qualified person.

INSTALLATION

- ☞ a) Make sure the power supply cord to the cooler is unplugged
- ☞ b) Shut off mains water
- ☞ c) Place the water cooler a minimum of 6 centimeters/2 inches away from the wall to assure proper ventilation.
- ☞ d) Remove the existing Crystal Guard or DryGuard™ lid (if necessary) and install the POU lid on top of the cooler, turning it clockwise.
- ☞ e) Install mains connection fittings, protection and regulatory fittings, filter and commission POU cooler as in details below.

 f) Further installation steps appear after the following details, starting at g.

 **Please ensure the following sequence for installation of fittings:**

- 1) Saddle Valve or Stop Tap/Isolating Valve
- 2) PRV/PLV if nec.
- 3) Leak Protection Device
- 4) Filter
- 5) Cooler

Water Mains Supply Connection

Saddle Valve or Stop Tap

Installer should check with Building Maintenance to check what of the following type of connection to the mains water system is recommended for their particular premises, as it does vary. One advantage of using a saddle valve or stop tap/isolating valve is to enable you to turn off the water supply to the cooler, and not have to shut off entire building supply to service the cooler. The following are suitable for connecting POU coolers:

- A self connecting (cutting) saddle valve
- A hard TEE connection (this is the compression type) with stop tap/isolating valve
- A Sweated TEE (this is the soldered type) with stop tap/isolating valve

** Always read the installation instructions accompanying the saddle valve or TEE + stop tap.**

Before installing water supply connection, ensure the water supply is shut off upstream of where you are connecting. Ensure surface area of pipe is free from paint, grease, etc.

Follow all guidelines to avoid hazards, particularly as regards electrical points. Even with precautions, there is always the possibility of water leak. If an electrical point such as a socket, fuse box or junction box is below or close to a mains connection there is the remote possibility that a water leak could cause an electrical problem.

After connecting, it is advisable to flush the water supply prior to final installation of the POU cooler. This will flush out any deposits or foreign bodies that could shorten the life of any filters that might be fitted.

Pressure Reducing/Limiting Valve

The recommended installation position of the PLV is at the point of connection to the water supply regardless of the water supply pressure – right next to the saddle valve or stop tap. Installation of Pressure Limiting Valve will protect the POU cooler and pipe work if it is installed at the connection to the water supply. If it is installed on the POU cooler the pipe work upstream will not be protected.

Crystal Mountain recommends using a PLV when:

- The water supply pressure exceeds the recommended maximum water inlet pressure for the POU cooler or any other component part of the installation (i.e., filter, tubing etc)
- There is a possibility or the occurrence of water hammer or other variances of water pressure causing abnormal spikes in normal water supply pressure.



WARNING:

Maximum water pressure (including any possible pressure spikes) of cold water supply line must not exceed 45 psi.

Manufacturer accepts no liability for property damage caused by excessive water pressure or improper plumbing.

The weakest part of any POU installation is that with the lowest working pressure rating. While the cooler may be rated at up to 150 psi, the pipe work may be rated at 50 psi, albeit with a 3 x burst factor (150 psi). Filters in particular can be damaged by excessive water pressure and not meet their design efficiency when rated pressure is exceeded. Water hammer can cause the normal water pressure to increase by up to a factor of 5. i.e. normal water pressure 45 psi \times 5 = 225psi at peak of hammer.

Leak Detection and Prevention Device (Waterblock)

Crystal Mountain recommends that Leak Detection and Prevention Devices should be installed on all Point of Use coolers. However, installation of such devices must not replace best industry practices to minimize the potential for leaks in the first place.

- Leak Detection Devices should be at the point of connection to the mains of a potable water supply, next to Saddle Valve or Stop tap and PRV
- To gain maximum performance from Leak Detection Devices it is advisable to read the manufacturer instruction before installation as some indicate that their device should be installed in an UPRIGHT POSITION.
- Care should be taken to ensure that the flow setting is correct for maximum effectiveness. While such systems will identify a leak in excess of the setting (ie 5 litres per minute or 5 litres continuous flow), if set improperly, they will not detect smaller leaks which may, over time, cause similar damage.

Connection to the POU Cooler

Tubing













When installing using microbore tubing the following guidelines apply. These are designed to prevent damage to the pipe work, minimize the risk of leaks and minimize any effect that the surrounding environment may have on the water contained in the tubing.

- Tubing should be cut with a sharp instrument ensuring a straight cut.
- Tubing runs should be continuous and contain no joints.
- Runs should be kept as short as possible.
- Kinks and sharp bends should be avoided.
- Runs should be kept away from any heat source, central heating or other.
- Runs should be kept away from light fittings, electrical cables, air conditioning units etc.
- Tubing should be sheathed to avoid abrasion when passing through walls or surfaces.

- viii) Tubing should be secured along its route by the use of clips, cable ties or other fixings designed to prevent movement during use.
- ix) Exposed tubing should be secured or placed in dedicated conduit, trunking or other covering (existing conduit containing electrical cables must be avoided).
- x) Tubing that is exposed to extreme temperatures should be lagged/insulated to prevent overheating or freezing.
- xi) Sufficient tubing should be used at the point of connection to the POU cooler to allow for movement of the cooler for maintenance, cleaning etc.
- xii) Tubing should be readily identifiable as a water supply by manufacturer branding, tagging, labeling or other manner that cannot be easily removed
- xiii) While tubing may be concealed within the fabric of the building (ie within a suspended false ceiling) it must be accessible for maintenance purposes

INSTALLATION cont.

-  g) The tubing can terminate either directly into the POU cooler itself or into a filter not fitted within the POU Cooler i.e. Counter Top Cooler.
-  h) Connect ¼ inch O.D. plastic tubing through POU cover and to the water inlet stub on the POU lid.
-  i) Connect the other end of the tubing to the cold water supply, if Pressure reducing valves, water-blocks, and filters are fitted please ensure that they are fitted according to the manufacturer guidelines and instructions, ensuring that the water flow directions through these components is correct.
-  j) Once the water supply is installed ensure that tubing runs are fully flushed prior to connection to the filter or POU cooler to remove any loose material that may cause blockage downstream. Flushing the tubing protects filters and the POU cooler from unintentional contamination.
-  k) Turn water supply on allowing reservoir to fill, making sure float mechanism is working correctly, reset where and if necessary
-  l) Check all water connections and look for any water leaks. Check water flows freely from the faucets.
-  m) Plug in the power cord. Turn the hot tank switch ON (if applicable).
-  n) Turn electric supply on to allow cooler to chill.
-  o) Allow 45 minutes to let the water reach optimum cool or hot temperatures.
-  p) Dispense 1.5 to 2.0 litres of water from both faucets (taps) checking both work correctly. This will also indicate that the float mechanism is operating as it should, allowing the reservoir to refill.

Commissioning the POU Cooler

The following checks should be made after your installer has completed installation processes above:

- A. Open all isolating valves and check fitting.
- B. Check all connections for leaks.
- C. Check water delivery temperatures.
- D. Check all labels are fitted to Cooler.
- E. Sanitise the Cooler in accordance with manufacturers guidelines
- F. Complete final clean of the Cooler
- G. Clean the working area of all installation debris.
- H. Carry out handover procedure including showing where all stop taps and electrical connections are.
- I. Demonstrate the correct operation of the unit to the customer.
- J. Obtain customer satisfaction signature.
- K. Explain the procedure the customer should follow in the event of a fault.

AFTER INSTALLATION

- Cooler and POU parts should be cleaned as per manufacturer instructions.
- Filter should be changed regularly as per manufacturer's instructions.
- Periodically inspect float operation by removing the POU lid from the cooler and manually raising the float to see that it stops water flow into the reservoir.
- It is customer/end user responsibility to empty the drip tray.

REMOVING COOLER FROM OPERATION

Ensure the following when the cooler is to be withdrawn from service:

- a) Disconnect power supply cord.
- b) Shut off water supply to the cooler.
- c) Use bucket to drain water from cold water reservoir through faucets. On Hot & Cold models, allow 1 hour for the hot water to cool down inside the hot tank before removing the drain plug at the rear of the cooler to drain hot tank.

CAUTION!

Always drain water completely before shipping or storing the cooler.

On Hot & Cold units, be sure to drain cooled hot tank water by removing the drain plug at rear of cooler after draining cold reservoir.



WARNING

- * The warranty and Canadian Standards Association, Underwriters' Laboratory and CE Listings for the cooler on which the POU Kit is installed are voided if failure to follow above instructions, alteration, modification, or combination with any other machine or device is deemed to be the source of any claim.
- * The manufacturer accepts no liability (including for bodily injury) resulting from any alteration, misuse, neglect, accidents, improper installation or repairs.
- * The red faucet dispenses hot water during normal operation that may cause severe burns.

Children must not be left unsupervised near the cooler.

LIMITED WARRANTY

The Manufacturer, Crystal Mountain warrants the POU Kit, when installed and operated in accordance with the installation instructions, against defects in material and workmanship under normal use as follows:

- One (1) year from the date of sale to customer or 18 months from date of shipment from the factory, whichever is the latest, Crystal Mountain, at their option will repair or replace any defective part.
- This warranty does not cover any damage due to accident, freight damage, misuse, abuse, negligence; fouling of components due to liming, dirt, unsatisfactory water conditions or faulty plumbing. Crystal Mountain does not accept responsibility for personal injury resulting from misuse of equipment.
- Except as set forth herein, Crystal Mountain makes no other warranty, guarantee or agreement expressed, implied or statutory, including any implied warranty of merchantability or fitness for a particular purpose. In no event, will the manufacturer be liable for special or consequential damages or for any delay in the performance of this agreement due to causes beyond their control.

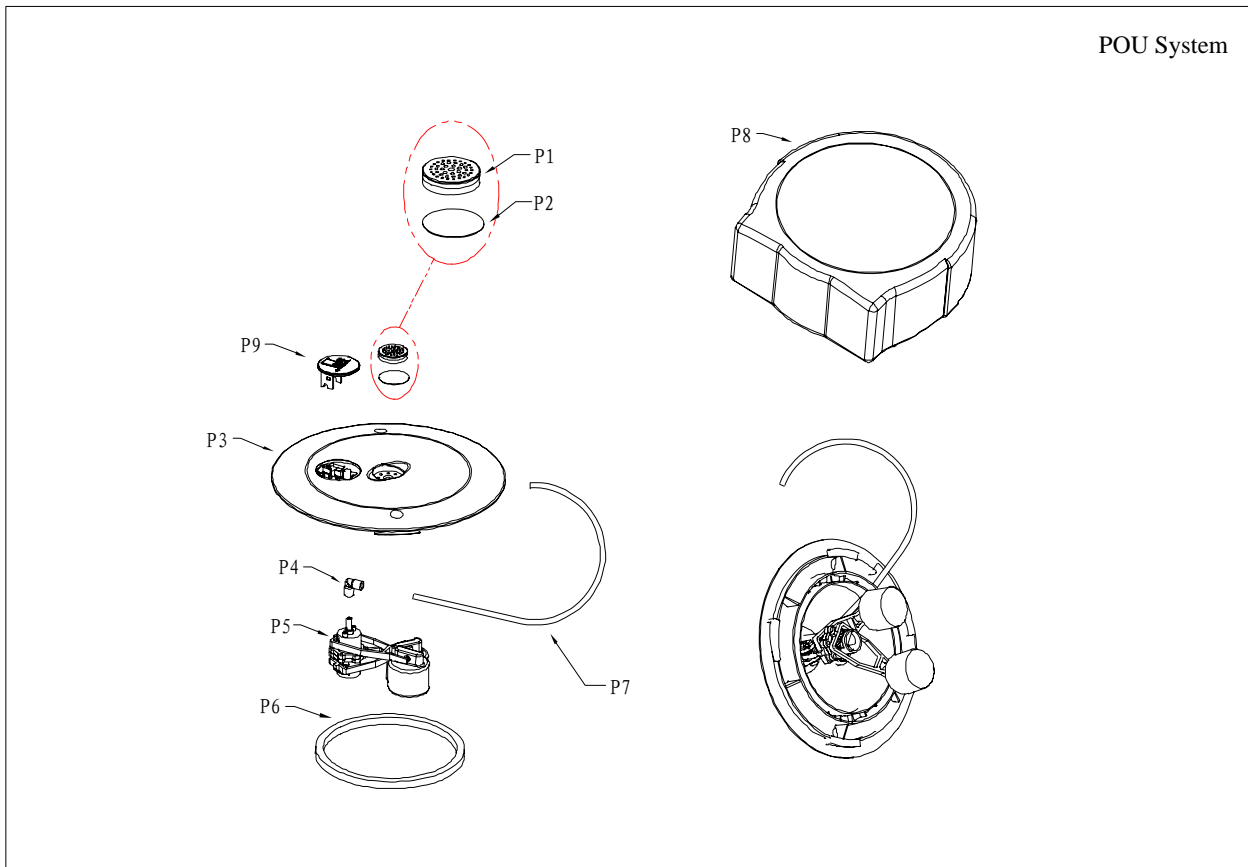

POU

| No. | DESCRIPTION | PART No. |
|-----|---|-------------|
| P1 | INDICATOR ASSM-FILTER CAP | PLC-C100056 |
| P2 | AIR FILTRATION MEDIA 5 MICRON | MIS-C000048 |
| P3 | INDICATOR ASSM-LID | PLC-C100057 |
| P4 | 1/4" POU PLASTIC ELBOWS | MIS-C000044 |
| P5 | POU FLOAT ASSEMBLY | MIS-C000043 |
| P6 | GASKET, POU LID | SIL-C000026 |
| P7 | 1/4" TUBING FOR POU SYSTEMS | SIL-C000019 |
| P8 | GLACIER POU WHITE COVER | PLC-C000133 |
| | GLACIER POU GRANITE COVER | PLC-C000195 |
| | MOGUL POU WHITE COVER | PLC-C100107 |
| P9 | POU INDICATOR ASSEMBLY(NO COVER) | SUB-C000216 |
| | POU INDICATOR ASSEMBLY WITH WHITE GLACIER COVER | SUB-C100007 |
| | POU INDICATOR ASSEMBLY WITH GRANITE GLACIER COVER | SUB-C100048 |
| | POU INDICATOR ASSEMBLY WITH WHITE MOGUL COVER | SUB-C100092 |